

PRODUCT SPECIFICATIONS

The following pages contain engineering data and product specifications for Trantorque Keyless Bushings.

TO DOWNLOAD FILES

For CAD drawings of Trantorque GT and QC, please click on the part number to begin the download process. You will be given the choice of 2D AutoCAD® ver. 12 or a 3D .igs file.

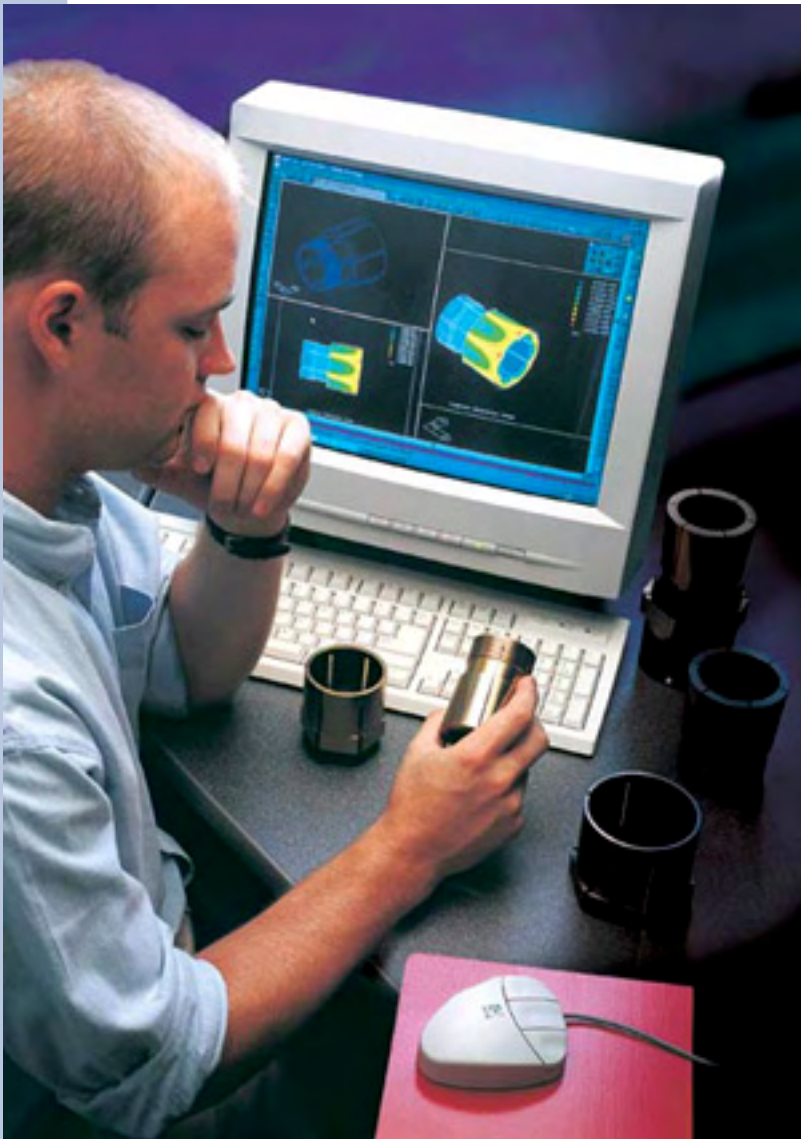

TRANTORQUE GT

ENGINEERING DATA

SELECTION

SPECIFICATIONS
INCH SYSTEM

SPECIFICATIONS
METRIC SYSTEM

MINIMUM HUB DIAMETER

SPECIAL UNITS

ELECTROLESS NICKEL PLATED

STAINLESS STEEL

S SERIES

NON-TRAVERSING

TRANTORQUE QC

Trantorque GT

Shaft and Bore Tolerance

Shaft diameter and component bore must be within:

Mini Series:	±0.0015"	(±0.04mm)
Standard Series:	±0.003"	(±0.08mm)
Large Series:	±0.003"	(±0.08mm)

Shaft and Hub Finish

The Trantorque GT unit performs best when the shaft and hub surface finish is between 32 and 125 Ra (roughness average). Lab tests have shown that a 63 Ra finish is optimum. If the surface finish is unknown, a medium grade of emery paper may be used to obtain an adequate surface finish.

Runout Tolerance

The unique design of the Trantorque GT provides extremely accurate concentricity and superior balance. All Trantorque GT units are concentric within .001" T.I.R. (0.025mm).

Synthetic Mounted Components

Trantorque GT units are not recommended for use with any component completely constructed of a synthetic material. Most of these types of materials have a certain amount of creep under load which will cause loosening over time. A Trantorque GT unit can be used if the bore of the synthetic component incorporates a reinforcing metal sleeve.

Temperature

When the shaft and mating hub are made from steel, Trantorque GT units are not affected by temperature within wide limits of -30°F to +400°F (-34°C to +204°C). If the shaft and/or mating component are made from different materials, such as aluminum, engineering compensation should be made for the difference in expansion coefficients. In common factory environments where the temperature may vary 100°F (55°C) from winter to summer, most applications will require no compensation, even when dissimilar metals are used.

Axial Movement

A characteristic of Trantorque GT is axial movement as installation torque is applied to the nut. This motion is not unique to Trantorque GT, but occurs in any tapered mounting device.

This movement from hand-tight to full installation torque is always in the direction in which the nut is being tightened. The inner element will remain secured to the shaft where it was located at hand-tight. The nut, outer element and component will all move together as the nut is tightened. The distance they move is approximately:

Mini Series:	0.045"	(1.1mm)
Standard Series:	0.075"	(1.9mm)
Large Series:	0.075"	(1.9mm)

If no axial movement can be tolerated, Fenner Drives offers a Non-Traversing design which prevents any axial thrust being applied to the mounted component. Therefore, no movement will occur in the axial direction on installation.

Bearings

Mounting bearings with Trantorque GT is not recommended. The expansion forces created when tightening the nut could be sufficient to distort the bearing's inner race, causing premature failure.

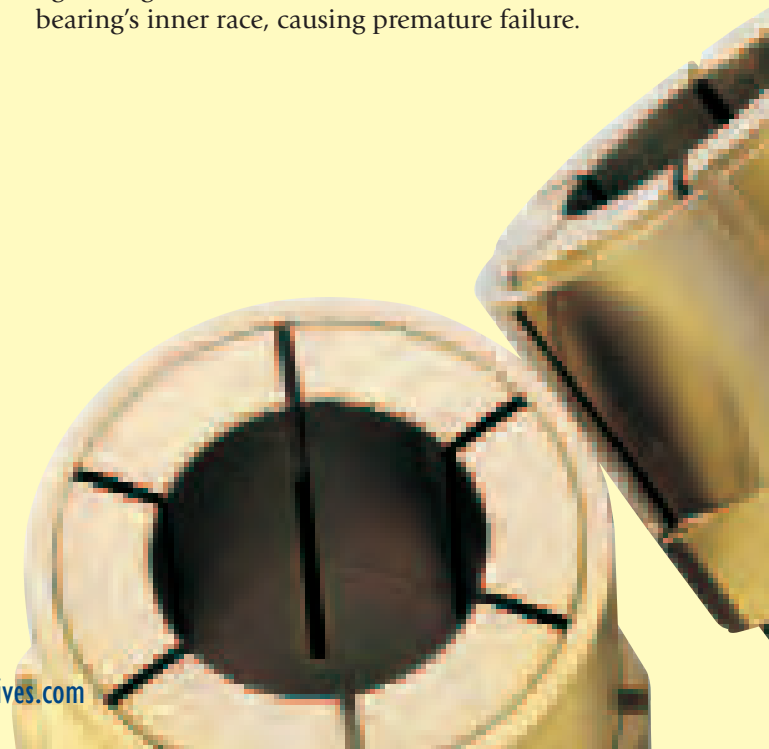

Using Two Trantorque GT Units

A tube or hollow shaft, two stub shafts and two Trantorque GT units are often used to make up rollers for live roller conveyors. Using Trantorque GT completely eliminates welding the stub shafts in the end of the tube and the machining necessary to maintain concentricity.

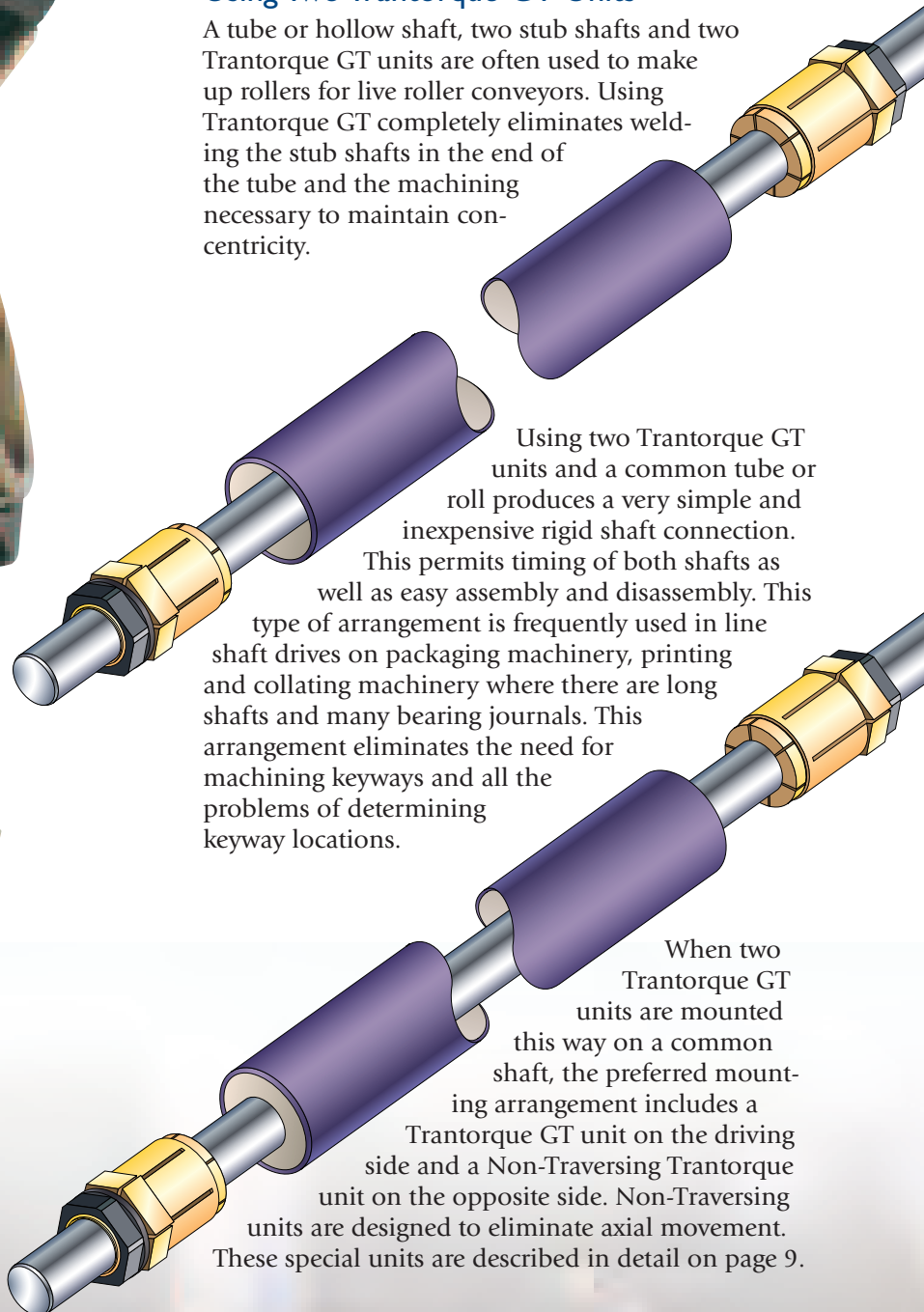

Using two Trantorque GT units and a common tube or roll produces a very simple and inexpensive rigid shaft connection.

This permits timing of both shafts as well as easy assembly and disassembly. This type of arrangement is frequently used in line shaft drives on packaging machinery, printing and collating machinery where there are long shafts and many bearing journals. This arrangement eliminates the need for machining keyways and all the problems of determining keyway locations.

When two Trantorque GT units are mounted this way on a common shaft, the preferred mounting arrangement includes a

Trantorque GT unit on the driving side and a Non-Traversing Trantorque unit on the opposite side. Non-Traversing units are designed to eliminate axial movement. These special units are described in detail on page 9.

To select the best Trantorque GT unit for your application, simply follow the step-by-step procedure outlined below. Before selecting a Trantorque GT unit, you need to know the following information about the application:

1. Shaft size
2. Transmitted torque
3. Component material
4. Component material yield strength
5. Type of prime mover (electric motor, engine, etc.)
6. Type of machine (fan, punch press, etc.)
7. Trantorque GT operating RPM
8. Additional reduction ratios (reducer, chain drive, etc.)

Procedure	Solution
1. Shaft diameter is 2-1/4" 2. Transmitted torque of 7000 in. lbs. Note: If you are not sure of the required torque for your application, use the following formula to arrive at an approximate value. $\text{Torque (in. lbs.)} = \frac{\text{HP} \times 63025}{\text{RPM}}$ Note: If the application also involves thrust load, proceed with step 2a, otherwise continue to step 3. 2a. The total allowable force is a combination of force due to torque and force due to thrust (Ft+Fth). For the total allowable force, always use the thrust values from the specification table. To determine the maximum transmissible torque (Mtt), multiply the force (F) by the shaft radius.	1. Part # 6202568 from specifications table. 2. Part # 6202568 has a maximum transmissible torque rating of 15,000 in. lbs. (See specifications table.) 2a. Consider a thrust load on the 2-1/4" shaft of 3000lbs. Total allowable thrust for part # 6202568 is 15,275 lbs. (from specifications table). Therefore, the total allowable force (F) is 15,275 - 3,000 = 12,275 lbs.
3. Refer to the Design Factor chart and determine the Design Factor based on the type of prime mover and the driven machine. Divide the maximum transmissible torque (Mtt) by the design factor.	3. Example: For an electric motor and a printing press, the design factor would be 1.25. 15,000 in. lbs./1.25 = 12,000 in. lbs. Trantorque GT unit is sufficient and has an actual design factor of 2.14. (i.e. 15000 in. lbs./7000 in. lbs. = 2.14)
4. Trantorque GT units exert an outward pressure and it is imperative that the component hub diameter be large enough to resist these pressures. Insufficient hub diameter could break under these forces. Use the formula below to calculate hub diameter. $D_h = \frac{H_p \times D}{S - \frac{H_p}{2}} + D$ where Dh = required hub diameter D = component bore size Hp = contact hub pressure S = yield tensile strength (si) These figures are based on the mounted component completely engaging the L ₂ dimension of the unit. For those applications where the component does not cover the L ₂ , the hub pressures increase proportionally. See formula. $H_p = PP \times \frac{L_2}{L}$ where PP = published hub pressure L ₂ = published length L = component length through bore	4. From the specification chart, component bore size is 3-1/8 (dimension D). Contact hub pressure (Hp) is 3500. Using the following formula, calculate required hub diameter. Use steel for the material and a yield strength of 36,000 psi. Published L ₂ is 2.125. Component engages 2.0". $H_p = 3500 \times \frac{2.125}{2.0}$ New Hp is 3718.75. Calculate hub diameter: $D_h = \frac{3718.75 \times 3.125}{36000 - \frac{3718.75}{2}} + 3.125$ Minimum hub diameter is 3.465".

Shaft and Bore Tolerance

Shaft diameter and component bore must be within:

Mini Series:	±0.0015"	(±0.04mm)
Standard Series:	±0.003"	(±0.08mm)
Large Series:	±0.003"	(±0.08mm)

Driven Machine Classifications

Even Loads

Agitators for liquids
 Blowers and Exhausters
 Centrifugal Pumps / Compressors
 Generators
 Conveyors: light package, oven
 Mixers
 Textile Machinery: warpers, twistlers, spinning frames, etc.
 Bottling Machinery
 Clarifier / Classifier
 Compressors: screw, lobe
 Dynamometer

Electric Motors, Turbines	1.00
Multi-Cylinder Engines	1.25
Single Cylinder Engines	1.50

Moderate Shock Loads

Concrete Mixers
 Conveyors: Bucket, Pan, Drag
 Piston Compressors
 Pumps: Gear, Rotary, Lobe
 Printing Press
 Paper Mill: Calendar, Dryer
 Machine Tools
 Laundry Washer / Tumbler

Electric Motors, Turbines	1.25
Multi-Cylinder Engines	1.50
Single Cylinder Engines	1.75

Heavy Shock Loads

Brick Machinery
 Punch Presses
 Hammer Mills
 Pulverizers
 Crushers
 Lumber Mill Machinery
 Piston Compressors
 Piston Pumps
 Ball / Tube Mills

Electric Motors, Turbines	1.75
Multi-Cylinder Engines	2.00
Single Cylinder Engines	2.25

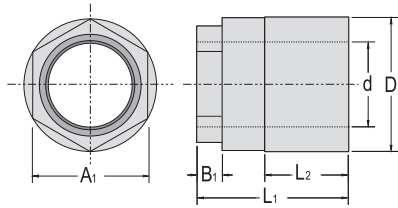

Mini Series

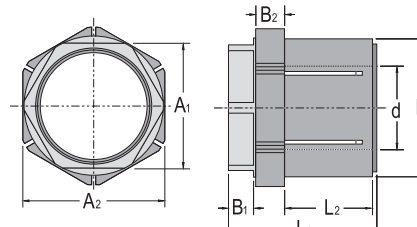

GT Series

INCH SYSTEM

	Part Number	Shaft Diameter (d)	Component Bore (D)	Max. Transmissible Torque (in. lbs.)	Thrust (lbs.)	Hub Pressure (psi)	L1	L2	A1	A2	B1	B2
Mini Series	6202102	1/8	5/8	100	700	5200	3/4	3/8	1/2	na	1/8	na
	6202103	3/16	5/8	100	700	5200	3/4	3/8	1/2	na	1/8	na
	6202105	1/4	5/8	150	790	5200	3/4	3/8	1/2	na	1/8	na
	6202107	5/16	3/4	200	890	3700	7/8	7/16	5/8	na	1/8	na
	6202109	3/8	3/4	250	925	3700	7/8	7/16	5/8	na	1/8	na
	6202110	7/16	7/8	300	950	2700	1	1/2	3/4	na	3/16	na
	6202112	1/2	7/8	350	980	2700	1	1/2	3/4	na	3/16	na
	6202114	9/16	1	400	990	1800	1-1/8	5/8	7/8	na	3/16	na
	6202115	5/8	1	450	1000	1800	1-1/8	5/8	7/8	na	3/16	na
	6202119	3/4	1-1/4	1500	2000	8000	1-3/8	3/4	1-1/16	na	1/4	na
Standard Series	6202120	5/8	1-1/2	1750	3300	11000	1-1/2	3/4	1-1/4	1-1/2	5/16	5/16
	6202140	11/16	1-1/2	2000	3850	11000	1-1/2	3/4	1-1/4	1-1/2	5/16	5/16
	6202160	3/4	1-1/2	2500	4400	11000	1-1/2	3/4	1-1/4	1-1/2	5/16	5/16
	6202190	13/16	1-3/4	2600	4950	9400	1-7/8	7/8	1-1/2	1-3/4	7/16	3/8
	6202200	7/8	1-3/4	2800	5500	9400	1-7/8	7/8	1-1/2	1-3/4	7/16	3/8
	6202220	15/16	1-3/4	3100	6050	9400	1-7/8	7/8	1-1/2	1-3/4	7/16	3/8
	6202240	1	1-3/4	3500	6600	9400	1-7/8	7/8	1-1/2	1-3/4	7/16	3/8
	6202270	1-1/16	2	4000	7000	7800	2-1/4	1	1-3/4	2	1/2	9/16
	6202280	1-1/8	2	4600	7500	7800	2-1/4	1	1-3/4	2	1/2	9/16
	6202300	1-3/16	2	5200	8000	7800	2-1/4	1	1-3/4	2	1/2	9/16
	6202320	1-1/4	2	6000	8500	7800	2-1/4	1	1-3/4	2	1/2	9/16
	6202350	1-5/16	2-3/8	6200	9000	6500	2-3/4	1-1/2	2	2-3/8	9/16	1/2
	6202360	1-3/8	2-3/8	6400	9500	6500	2-3/4	1-1/2	2	2-3/8	9/16	1/2
	6202380	1-7/16	2-3/8	6700	10000	6500	2-3/4	1-1/2	2	2-3/8	9/16	1/2
	6202400	1-1/2	2-3/8	7000	10500	6500	2-3/4	1-1/2	2	2-3/8	9/16	1/2
	6202430	1-9/16	2-5/8	8000	11000	5500	3-1/8	1-11/16	2-1/4	2-5/8	9/16	11/16
	6202440	1-5/8	2-5/8	8500	11750	5500	3-1/8	1-11/16	2-1/4	2-5/8	9/16	11/16
	6202460	1-11/16	2-5/8	9250	12250	5500	3-1/8	1-11/16	2-1/4	2-5/8	9/16	11/16
	6202480	1-3/4	2-5/8	10000	12750	5500	3-1/8	1-11/16	2-1/4	2-5/8	9/16	11/16
	6202510	1-13/16	2-7/8	11000	13250	4200	3-9/16	2	2-1/2	2-7/8	5/8	3/4
6202520	1-7/8	2-7/8	11750	14000	4200	3-9/16	2	2-1/2	2-7/8	5/8	3/4	
6202540	1-15/16	2-7/8	12750	14500	4200	3-9/16	2	2-1/2	2-7/8	5/8	3/4	
6202560	2	2-7/8	14000	15000	4200	3-9/16	2	2-1/2	2-7/8	5/8	3/4	
Large Series	6202562	2-1/16	3-1/8	14250	15100	3500	3-3/4	2-1/8	2-3/4	3-1/8	5/8	13/16
	6202564	2-1/8	3-1/8	14500	15200	3500	3-3/4	2-1/8	2-3/4	3-1/8	5/8	13/16
	6202566	2-3/16	3-1/8	14750	15250	3500	3-3/4	2-1/8	2-3/4	3-1/8	5/8	13/16
	6202568	2-1/4	3-1/8	15000	15275	3500	3-3/4	2-1/8	2-3/4	3-1/8	5/8	13/16
	6202570	2-5/16	3-3/8	15250	15330	2800	3-7/8	2-1/4	3	3-3/8	11/16	3/4
	6202572	2-3/8	3-3/8	15500	15400	2800	3-7/8	2-1/4	3	3-3/8	11/16	3/4
	6202574	2-7/16	3-3/8	15750	15480	2800	3-7/8	2-1/4	3	3-3/8	11/16	3/4
	6202576	2-1/2	3-3/8	16000	15550	2800	3-7/8	2-1/4	3	3-3/8	11/16	3/4
	6202580	2-9/16	3-5/8	16250	15620	2400	4-1/16	2-3/8	3-1/4	3-5/8	11/16	13/16
	6202582	2-5/8	3-5/8	16500	15680	2400	4-1/16	2-3/8	3-1/4	3-5/8	11/16	13/16
	6202584	2-11/16	3-5/8	16750	15750	2400	4-1/16	2-3/8	3-1/4	3-5/8	11/16	13/16
	6202586	2-3/4	3-5/8	17000	15800	2400	4-1/16	2-3/8	3-1/4	3-5/8	11/16	13/16
	6202590	2-13/16	3-7/8	17250	15900	2300	4-1/4	2-1/2	3-1/2	3-7/8	3/4	13/16
	6202592	2-7/8	3-7/8	17500	15950	2300	4-1/4	2-1/2	3-1/2	3-7/8	3/4	13/16
	6202594	2-15/16	3-7/8	17750	16025	2300	4-1/4	2-1/2	3-1/2	3-7/8	3/4	13/16
	6202596	3	3-7/8	18000	16150	2300	4-1/4	2-1/2	3-1/2	3-7/8	3/4	13/16

Dimensions are for reference only.

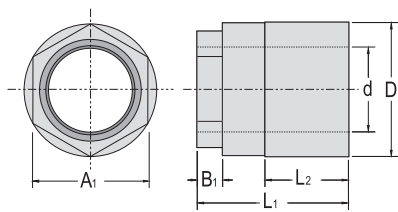

Mini Series

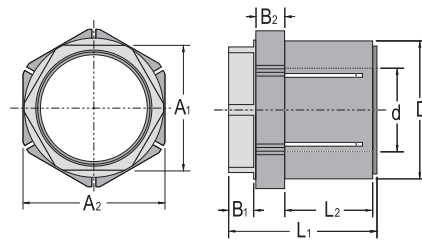

GT Series

METRIC SYSTEM

	Part Number	Shaft Diameter (d)	Component Bore (D)	Max. Transmissible		Hub Pressure (N/cm ²)	L1	L2	A1	A2	B1	B2
				Torque (Nm)	Thrust (kN)							
Mini Series	6202640	3	16.0	12	3.2	3585	19.1	9.5	13.0	na	3.2	na
	6202645	4	16.0	12	3.2	3585	19.1	9.5	13.0	na	3.2	na
	6202650	5	16.0	12	3.2	3585	19.1	9.5	13.0	na	3.2	na
	6202660	6	16.0	16	3.4	3585	19.1	9.5	13.0	na	3.2	na
	6202670	7	19.0	20	3.5	2550	22.2	11.1	15.9	na	3.2	na
	6202680	8	19.0	23	4.0	2550	22.2	11.1	15.9	na	3.2	na
	6202690	9	19.0	26	4.1	2550	22.2	11.1	15.9	na	3.2	na
	6202700	10	22.5	30	4.2	1860	25.7	12.7	19.0	na	4.8	na
	6202710	11	22.5	34	4.2	1860	25.7	12.7	19.0	na	4.8	na
	6202720	12	22.5	39	4.3	1860	25.7	12.7	19.0	na	4.8	na
	6202740	14	25.5	44	4.4	1240	28.6	15.9	22.0	na	4.8	na
	6202750	15	25.5	45	4.4	1240	28.6	15.9	22.0	na	4.8	na
	6202760	16	25.5	50	4.5	1240	28.6	15.9	22.0	na	4.8	na
	6202770	17	32.0	170	8.9	5500	34.9	19.1	27.0	na	6.4	na
Standard Series	6202800	15	38.0	180	13.4	7590	38.1	19.1	31.8	38.1	8.0	8.9
	6202803	16	38.0	198	15.0	7590	38.1	19.1	31.8	38.1	8.0	8.9
	6202804	17	38.0	220	17.0	7590	38.1	19.1	31.8	38.1	8.0	8.9
	6202805	18	38.0	265	18.1	7590	38.1	19.1	31.8	38.1	8.0	8.9
	6202808	19	38.0	282	19.9	7590	38.1	19.1	31.8	38.1	8.0	8.9
	6202811	20	45.0	290	21.0	6480	47.6	22.2	38.0	44.5	11.1	9.5
	6202815	22	45.0	315	24.1	6480	47.6	22.2	38.0	44.5	11.1	9.5
	6202820	24	45.0	380	27.2	6480	47.6	22.2	38.0	44.5	11.1	9.5
	6202825	25	45.0	390	28.7	6480	47.6	22.2	38.0	44.5	11.1	9.5
	6202830	28	51.0	495	32.6	5380	57.2	25.4	46.0	50.8	12.7	14.3
	6202835	30	51.0	580	35.4	5380	57.2	25.4	46.0	50.8	12.7	14.3
	6202840	32	51.0	680	38.2	5380	57.2	25.4	46.0	50.8	12.7	14.3
	6202845	34	60.5	710	41.0	4480	69.9	38.1	50.0	60.3	14.3	12.7
	6202850	35	60.5	725	42.4	4480	69.9	38.1	50.0	60.3	14.3	12.7
	6202855	36	60.5	750	43.8	4480	69.9	38.1	50.0	60.3	14.3	12.7
	6202860	38	60.5	790	46.6	4480	69.9	38.1	50.0	60.3	14.3	12.7
	6202865	40	67.0	900	49.7	3790	79.4	42.9	60.0	66.7	14.3	17.4
	6202870	42	67.0	1000	53.3	3790	79.4	42.9	60.0	66.7	14.3	17.4
6202876	45	73.0	1170	57.5	2900	90.5	50.8	65.0	73.0	15.9	19.1	
6202880	48	73.0	1355	62.9	2900	90.5	50.8	65.0	73.0	15.9	19.1	
6202885	50	73.0	1510	65.7	2900	90.5	50.8	65.0	73.0	15.9	19.1	
Large Series	6202900	55	80.0	1650	67.8	2400	95.3	54.0	69.9	79.4	15.9	20.7
	6202910	60	86.0	1740	68.7	1930	98.4	57.2	75.0	85.7	17.5	19.1
	6202920	65	92.0	1930	69.5	1660	103.2	60.3	82.0	92.1	17.5	20.7
	6202930	70	92.0	1920	70.4	1660	103.2	60.3	82.0	92.1	17.5	20.7
	6202940	75	100.0	2000	71.5	1600	108.0	63.5	90.0	98.4	19.1	20.7

Dimensions are for reference only.

Listed below are the minimum recommended hub diameters needed to resist the outward forces generated by a Trantorque GT unit. These values are based on the mounted component completely covering the L₂ dimension of the unit. For those applications where the mounted component does not completely cover the L₂ dimension, the minimum hub diameter should be calculated using the formulas in the [SELECTION](#) section of this catalog.

	Shaft Diameter	Trantorque o.d. (D)	Hub Pressure	Material Yield Strength (psi)									
				20000	25000	30000	35000	40000	45000	50000	55000	60000	
				Minimum Hub Diameter (Factor of Safety = 1.0)									
Mini Series	3/16	5/8	5200	0.812	0.770	0.774	0.725	0.712	0.702	0.694	0.687	0.682	
	1/4	5/8	5200	0.812	0.770	0.774	0.725	0.712	0.702	0.694	0.687	0.682	
	5/16	3/4	3700	0.903	0.870	0.849	0.834	0.823	0.814	0.808	0.802	0.798	
	3/8	3/4	3700	0.903	0.870	0.849	0.834	0.823	0.814	0.808	0.802	0.798	
	7/16	7/8	2700	1.002	0.975	0.957	0.945	0.936	0.929	0.924	0.919	0.915	
	1/2	7/8	2700	1.002	0.975	0.957	0.945	0.936	0.929	0.924	0.919	0.915	
	9/16	1	1800	1.094	1.075	1.062	1.053	1.046	1.041	1.037	1.033	1.030	
	5/8	1	1800	1.094	1.075	1.062	1.053	1.046	1.041	1.037	1.033	1.030	
	3/4	1-1/4	8000	1.875	1.726	1.635	1.573	1.528	1.494	1.467	1.446	1.429	
Standard Series	5/8	1-1/2	11000	2.638	2.346	2.173	2.059	1.978	1.918	1.871	1.833	1.803	
	11/16	1-1/2	11000	2.638	2.346	2.173	2.059	1.978	1.918	1.871	1.833	1.803	
	3/4	1-1/2	11000	2.638	2.346	2.173	2.059	1.978	1.918	1.871	1.833	1.803	
	13/16	1-3/4	9400	2.825	2.560	2.400	2.293	2.216	2.158	2.113	2.077	2.047	
	7/8	1-3/4	9400	2.825	2.560	2.400	2.293	2.216	2.158	2.113	2.077	2.047	
	15/16	1-3/4	9400	2.825	2.560	2.400	2.293	2.216	2.158	2.113	2.077	2.047	
	1	1-3/4	9400	2.825	2.560	2.400	2.293	2.216	2.158	2.113	2.077	2.047	
	1-1/16	2	7800	2.969	2.739	2.598	2.502	2.432	2.380	2.338	2.305	2.278	
	1-1/8	2	7800	2.969	2.739	2.598	2.502	2.432	2.380	2.338	2.305	2.278	
	1-3/16	2	7800	2.969	2.739	2.598	2.502	2.432	2.380	2.338	2.305	2.278	
	1-1/4	2	7800	2.969	2.739	2.598	2.502	2.432	2.380	2.338	2.305	2.278	
	1-5/16	2-3/8	6500	3.297	3.085	2.952	2.861	2.795	2.745	2.705	2.673	2.647	
	1-3/8	2-3/8	6500	3.297	3.085	2.952	2.861	2.795	2.745	2.705	2.673	2.647	
	1-7/16	2-3/8	6500	3.297	3.085	2.952	2.861	2.795	2.745	2.705	2.673	2.647	
	1-1/2	2-3/8	6500	3.297	3.085	2.952	2.861	2.795	2.745	2.705	2.673	2.647	
	1-9/16	2-5/8	5500	3.462	3.274	3.155	3.073	3.013	2.967	2.931	2.901	2.877	
	1-5/8	2-5/8	5500	3.462	3.274	3.155	3.073	3.013	2.967	2.931	2.901	2.877	
	1-11/16	2-5/8	5500	3.462	3.274	3.155	3.073	3.013	2.967	2.931	2.901	2.877	
	1-3/4	2-5/8	5500	3.462	3.274	3.155	3.073	3.013	2.967	2.931	2.901	2.877	
	1-13/16	2-7/8	4200	3.550	3.402	3.308	3.242	3.194	3.156	3.127	3.103	3.084	
1-7/8	2-7/8	4200	3.550	3.402	3.308	3.242	3.194	3.156	3.127	3.103	3.084		
1-15/16	2-7/8	4200	3.550	3.402	3.308	3.242	3.194	3.156	3.127	3.103	3.084		
	2	2-7/8	4200	3.550	3.402	3.308	3.242	3.194	3.156	3.127	3.103	3.084	
Large Series	2-1/16	3-1/8	3500	3.724	3.595	3.512	3.454	3.411	3.378	3.352	3.330	3.313	
	2-1/8	3-1/8	3500	3.724	3.595	3.512	3.454	3.411	3.378	3.352	3.330	3.313	
	2-3/16	3-1/8	3500	3.724	3.595	3.512	3.454	3.411	3.378	3.352	3.330	3.313	
	2-1/4	3-1/8	3500	3.724	3.595	3.512	3.454	3.411	3.378	3.352	3.330	3.313	
	2-5/16	3-3/8	2800	3.883	3.775	3.705	3.656	3.620	3.592	3.569	3.551	3.536	
	2-3/8	3-3/8	2800	3.883	3.775	3.705	3.656	3.620	3.592	3.569	3.551	3.536	
	2-7/16	3-3/8	2800	3.883	3.775	3.705	3.656	3.620	3.592	3.569	3.551	3.536	
	2-1/2	3-3/8	2800	3.883	3.775	3.705	3.656	3.620	3.592	3.569	3.551	3.536	
	2-9/16	3-5/8	2400	4.088	3.991	3.927	3.882	3.849	3.824	3.803	3.787	3.773	
	2-5/8	3-5/8	2400	4.088	3.991	3.927	3.882	3.849	3.824	3.803	3.787	3.773	
	2-11/16	3-5/8	2400	4.088	3.991	3.927	3.882	3.849	3.824	3.803	3.787	3.773	
	2-3/4	3-5/8	2400	4.088	3.991	3.927	3.882	3.849	3.824	3.803	3.787	3.773	
	2-13/16	3-7/8	2300	4.348	4.249	4.184	4.138	4.104	4.078	4.057	4.041	4.026	
	2-7/8	3-7/8	2300	4.348	4.249	4.184	4.138	4.104	4.078	4.057	4.041	4.026	
	2-15/16	3-7/8	2300	4.348	4.249	4.184	4.138	4.104	4.078	4.057	4.041	4.026	
		3	3-7/8	2300	4.348	4.249	4.184	4.138	4.104	4.078	4.057	4.041	4.026

Resist corrosion from washdown and hostile environments. Dimensionally the same as standard GT units. Available in all stock sizes. No minimum quantities required. Contact factory for price and availability.

PERFORMANCE SPECIFICATIONS

	Inch-Pound System				Metric System					
	Part Number	Shaft Diameter	Max. Transmissible Torque (in. lbs.)	Thrust (lbs.)	Hub Pressure (psi)	Part Number	Shaft Diameter	Max. Transmissible Torque (Nm)	Thrust (kN)	Hub Pressure (N/cm ²)
Mini Series	6202103EN	3/16	50	350	2600	6202650EN	5	6	1.6	1793
	6202105EN	1/4	75	395	2600	6202660EN	6	8	1.7	1793
	6202107EN	5/16	100	445	1850	6202670EN	7	10	1.8	1275
	6202109EN	3/8	125	463	1850	6202680EN	8	12	2.0	1275
	6202110EN	7/16	150	475	1350	6202690EN	9	13	2.1	1275
	6202112EN	1/2	175	490	1350	6202700EN	10	15	2.1	930
	6202114EN	9/16	200	495	900	6202710EN	11	17	2.1	930
	6202115EN	5/8	225	500	900	6202720EN	12	20	2.2	930
	6202119EN	3/4	750	1000	4000	6202740EN	14	22	2.2	620
						6202750EN	15	23	2.2	620
					6202760EN	16	25	2.3	620	
					6202770EN	17	85	4.5	2750	
Standard Series	6202120EN	5/8	875	1650	5500	6202800EN	15	90	6.7	3795
	6202140EN	11/16	1000	1925	5500	6202803EN	16	99	7.5	3795
	6202160EN	3/4	1250	2200	5500	6202804EN	17	110	8.5	3795
	6202190EN	13/16	1300	2475	4700	6202805EN	18	133	9.1	3795
	6202200EN	7/8	1400	2750	4700	6202808EN	19	141	10.0	3795
	6202220EN	15/16	1550	3025	4700	6202811EN	20	145	11.0	3240
	6202240EN	1	1750	3300	4700	6202815EN	22	158	12.1	3240
	6202270EN	1-1/16	2000	3500	3900	6202820EN	24	190	13.6	3240
	6202280EN	1-1/8	2300	3750	3900	6202825EN	25	195	14.4	3240
	6202300EN	1-3/16	2600	4000	3900	6202830EN	28	248	16.3	2690
	6202320EN	1-1/4	3000	4250	3900	6202835EN	30	290	17.7	2690
	6202350EN	1-5/16	3100	4500	3250	6202840EN	32	340	19.1	2690
	6202360EN	1-3/8	3200	4750	3250	6202845EN	34	355	20.5	2240
	6202380EN	1-7/16	3350	5000	3250	6202850EN	35	363	21.2	2240
	6202400EN	1-1/2	3500	5250	3250	6202855EN	36	375	21.9	2240
	6202430EN	1-9/16	4000	5500	2750	6202860EN	38	395	23.3	2240
	6202440EN	1-5/8	4250	5875	2750	6202865EN	40	450	24.9	1895
	6202460EN	1-11/16	4625	6125	2750	6202870EN	42	500	26.7	1895
	6202480EN	1-3/4	5000	6375	2750	6202876EN	45	585	28.8	1450
	6202510EN	1-13/16	5500	6625	2100	6202880EN	48	678	31.5	1450
6202520EN	1-7/8	5875	7000	2100	6202885EN	50	755	32.9	1450	
6202540EN	1-15/16	6375	7250	2100						
6202560EN	2	7000	7500	2100						
Large Series	6202562EN	2-1/16	7125	7550	1750	6202900EN	55	825	33.9	1200
	6202564EN	2-1/8	7250	7600	1750	6202910EN	60	870	34.4	965
	6202566EN	2-3/16	7375	7625	1750	6202920EN	65	965	34.8	830
	6202568EN	2-1/4	7500	7638	1750	6202930EN	70	960	35.2	830
	6202570EN	2-5/16	7625	7665	1400	6202940EN	75	1000	35.8	800
	6202572EN	2-3/8	7750	7700	1400					
	6202574EN	2-7/16	7875	7740	1400					
	6202576EN	2-1/2	8000	7775	1400					
	6202580EN	2-9/16	8125	7810	1200					
	6202582EN	2-5/8	8250	7840	1200					
	6202584EN	2-11/16	8375	7875	1200					
	6202586EN	2-3/4	8500	7900	1200					
	6202590EN	2-13/16	8625	7950	1150					
	6202592EN	2-7/8	8750	7975	1150					
	6202594EN	2-15/16	8875	8013	1150					
6202596EN	3	9000	8075	1150						

For ultimate protection against washdown and hostile environments. Available in 303 stainless steel (non-magnetic) only. Stock sizes are indicated in red with other sizes available on a special order basis with minimum quantities. Dimensionally the same as standard GT units. Contact factory for price and availability. Consult factory when used with stainless steel shafts.

PERFORMANCE SPECIFICATIONS

	Inch-Pound System					Metric System					
	Part Number	Shaft Diameter	Max. Transmissible Torque (in. lbs.)	Thrust (lbs.)	Hub Pressure (psi)	Part Number	Shaft Diameter	Max. Transmissible Torque (Nm)	Thrust (kN)	Hub Pressure (N/cm ²)	
Mini Series	6990103	3/16	30	210	1560	6990650	5	4	1.0	1080	
	6990105	1/4	45	235	1560	6990660	6	5	1.0	108	
	6990107	5/16	60	265	1110	6990670	7	6	1.2	770	
	6990109	3/8	75	280	1110	6990680	8	7	1.2	770	
	6990110	7/16	90	285	810	6990690	9	8	1.2	770	
	6990112	1/2	105	295	810	6990700	10	9	1.2	560	
	6990114	9/16	120	295	540	6990710	11	10	1.3	560	
	6990115	5/8	135	300	540	6990720	12	12	1.3	560	
	6990119	3/4	450	600	2400	6990740	14	13	1.3	370	
						6990750	15	14	1.3	370	
						6990760	16	15	1.3	370	
						6990770	17	46	2.4	1650	
	Standard Series	6990120	5/8	525	990	3300	6990800	15	54	4.0	2280
		6990140	11/16	600	1155	3300	6990803	16	59	4.5	2280
		6990160	3/4	750	1320	3300	6990804	17	66	5.1	2280
6990190		13/16	780	1485	2820	6990805	18	80	5.4	2280	
6990200		7/8	840	1650	2820	6990808	19	85	6.0	2280	
6990220		15/16	930	1815	2820	6990811	20	87	6.3	1940	
6990240		1	1050	1980	2820	6990815	22	95	7.2	1940	
6990270		1-1/16	1200	2100	2340	6990820	24	114	8.2	1940	
6990280		1-1/8	1380	2250	2340	6990825	25	117	8.6	1940	
6990300		1-3/16	1560	2400	2340	6990830	28	149	9.8	1610	
6990320		1-1/4	1800	2550	2340	6990835	30	174	10.6	1610	
6990350		1-5/16	1860	2700	1950	6990840	32	204	11.5	1610	
6990360		1-3/8	1920	2850	1950	6990845	34	213	12.3	1340	
6990380		1-7/16	2010	3000	1950	6990850	35	218	12.7	1340	
6990400		1-1/2	2100	3150	1950	6990855	36	225	13.1	1340	
6990430		1-9/16	2400	3300	1650	6990860	38	237	14.0	1340	
6990440		1-5/8	2550	3525	1650	6990865	40	270	14.9	1140	
6990460		1-11/16	2775	3675	1650	6990870	42	300	16.0	1140	
6990480		1-3/4	3000	3825	1650	6990876	45	351	17.3	870	
6990510		1-13/16	3300	3975	1260	6990880	48	407	18.9	870	
6990520		1-7/8	3525	4200	1260	6990885	50	453	19.7	870	
6990540		1-15/16	3825	4350	1260						
6990560	2	4200	4500	1260							
Large Series	6990562	2-1/16	4275	4530	1050	6990900	55	495	20.3	720	
	6990564	2-1/8	4350	4560	1050	6990910	60	522	20.6	580	
	6990566	2-3/16	4425	4575	1050	6990920	65	549	20.9	500	
	6990568	2-1/4	4500	4585	1050	6990930	70	576	21.1	500	
	6990570	2-5/16	4575	4600	840	6990940	75	600	21.5	480	
	6990572	2-3/8	4650	4620	840						
	6990574	2-7/16	4725	4645	840						
	6990576	2-1/2	4800	4665	840						
	6990580	2-9/16	4875	4680	720						
	6990582	2-5/8	4950	4705	720						
	6990584	2-11/16	5025	4725	720						
	6990586	2-3/4	5100	4740	720						
	6990590	2-13/16	5175	4770	690						
	6990592	2-7/8	5250	4785	690						
	6990594	2-15/16	5325	4810	690						
	6990596	3	5400	4845	690						

A shortened version primarily designed for use with “A” plate chain sprockets, narrow synchronous belt sprockets, and for those applications where space is limited. Stock items are indicated in red with other sizes available on a special order basis. Minimum quantities are required for special orders. Contact factory for price and availability.

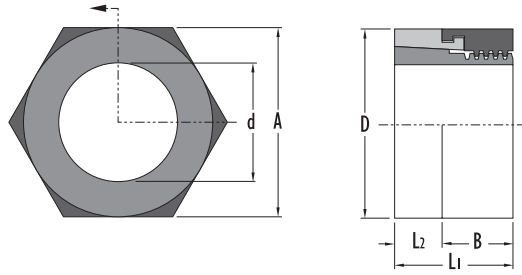
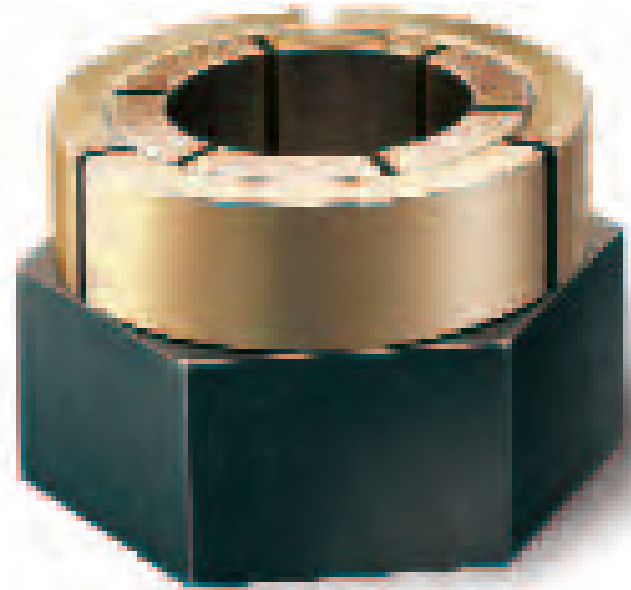

S Series

PERFORMANCE SPECIFICATIONS

	Part Number	Shaft Diameter (d)	Component Bore (D)	Maximum Transmissible		Hub Pressure (psi)	L1	L2	A	B
				Torque (in. lbs.)	Thrust (lbs.)					
Mini Series	6940103	3/16	5/8	100	700	7800	5/8	1/4	5/8	3/8
	6940105	1/4	5/8	150	790	7800	5/8	1/4	5/8	3/8
	6940107	5/16	3/4	200	890	6475	5/8	1/4	3/4	3/8
	6940109	3/8	3/4	250	925	6475	5/8	1/4	3/4	3/8
	6940110	7/16	7/8	300	950	3600	3/4	3/8	7/8	3/8
	6940112	1/2	7/8	350	980	3600	3/4	3/8	7/8	3/8
	6940114	9/16	1	400	990	3000	7/8	3/8	1	1/2
	6940115	5/8	1	450	1000	3000	7/8	3/8	1	1/2
	6940119	3/4	1-1/4	1500	2000	16000	1	3/8	1-1/4	5/8
Standard Series	6940120	5/8	1-1/2	1750	3300	16500	1-1/4	1/2	1-1/2	3/4
	6940140	11/16	1-1/2	2000	3850	16500	1-1/4	1/2	1-1/2	3/4
	6940160	3/4	1-1/2	2500	4400	16500	1-1/4	1/2	1-1/2	3/4
	6940190	13/16	1-3/4	2600	4950	16450	1-1/4	1/2	1-3/4	3/4
	6940200	7/8	1-3/4	2800	5500	16450	1-1/4	1/2	1-3/4	3/4
	6940220	15/16	1-3/4	3100	6050	16450	1-1/4	1/2	1-3/4	3/4
	6940240	1	1-3/4	3500	6600	16450	1-1/4	1/2	1-3/4	3/4
	6940270	1-1/16	2	4000	7000	15600	1-1/4	1/2	2	3/4
	6940280	1-1/8	2	4600	7500	15600	1-1/4	1/2	2	3/4
	6940300	1-3/16	2	5200	8000	15600	1-1/4	1/2	2	3/4
	6940320	1-1/4	2	6000	8500	15600	1-1/4	1/2	2	3/4
	6940350	1-5/16	2-3/8	6200	9000	19500	1-1/2	1/2	2-1/4	1
	6940360	1-3/8	2-3/8	6400	9500	19500	1-1/2	1/2	2-1/4	1
	6940380	1-7/16	2-3/8	6700	10000	19500	1-1/2	1/2	2-1/4	1
	6940400	1-1/2	2-3/8	7000	10500	19500	1-1/2	1/2	2-1/4	1
6940430	1-9/16	2-5/8	8000	11000	18565	1-1/2	1/2	2-1/2	1	
6940440	1-5/8	2-5/8	8500	11750	18565	1-1/2	1/2	2-1/2	1	
6940460	1-11/16	2-5/8	9250	12250	18565	1-1/2	1/2	2-1/2	1	
6940480	1-3/4	2-5/8	10000	12750	18565	1-1/2	1/2	2-1/2	1	

Specifically designed to prevent any axial thrust from being applied to the mounted component. Eliminates movement occurring in the axial direction on installation. Stock items are indicated in red. Other sizes are available on a special order basis. Contact the factory for price and availability. Minimum quantities required on non-stocked items.

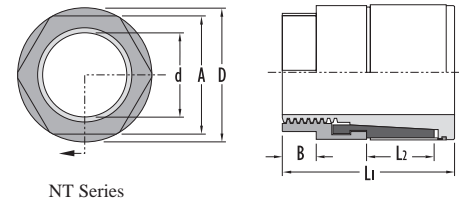

PERFORMANCE SPECIFICATIONS

	Part Number	Shaft Diameter (d)	Component Bore (D)	Maximum Transmissible		Hub Pressure (psi)	L1	L2	A	B
				Torque (in. lbs.)	Thrust (lbs.)					
Mini Series	6980103	3/16	5/8	70	490	3640	1-1/16	3/8	1/2	1/8
	6980105	1/4	5/8	105	553	3640	1-1/16	3/8	1/2	1/8
	6980107	5/16	3/4	140	623	2590	1-3/16	7/16	5/8	1/8
	6980109	3/8	3/4	175	648	2590	1-3/16	7/16	5/8	1/8
	6980110	7/16	7/8	210	665	1890	1-5/16	1/2	3/4	3/16
	6980112	1/2	7/8	245	686	1890	1-5/16	1/2	3/4	3/16
	6980114	9/16	1	280	693	1260	1-7/16	5/8	7/8	3/16
	6980115	5/8	1	315	700	1260	1-7/16	5/8	7/8	3/16
	6980119	3/4	1-1/4	1050	1400	5600	1-11/16	3/4	1-1/16	1/4
Standard Series	6980120X	5/8	1-1/2	1225	2310	7700	1-13/16	11/16	1-1/4	5/16
	6980140X	11/16	1-1/2	1400	2695	7700	1-13/16	11/16	1-1/4	5/16
	6980160X	3/4	1-1/2	1750	3080	7700	1-13/16	11/16	1-1/4	5/16
	6980190X	13/16	1-3/4	1820	3465	6850	2-3/16	13/16	1-1/2	7/16
	6980200X	7/8	1-3/4	1960	3850	6850	2-3/16	13/16	1-1/2	7/16
	6980220X	15/16	1-3/4	2170	4235	6850	2-3/16	13/16	1-1/2	7/16
	6980240X	1	1-3/4	2450	4620	6850	2-3/16	13/16	1-1/2	7/16
	6980270X	1-1/16	2	2800	4900	5460	2-9/16	15/16	1-3/4	1/2
	6980280X	1-1/8	2	3220	5250	5460	2-9/16	15/16	1-3/4	1/2
	6980300X	1-3/16	2	3500	5600	5460	2-9/16	15/16	1-3/4	1/2
	6980320X	1-1/4	2	4200	5950	5460	2-9/16	15/16	1-3/4	1/2
	6980350X	1-5/16	2-3/8	4340	6300	4550	3-3/32	1-7/16	2	9/16
	6980360X	1-3/8	2-3/8	4480	6650	4550	3-3/32	1-7/16	2	9/16
	6980380X	1-7/16	2-3/8	4690	7000	4550	3-3/32	1-7/16	2	9/16
	6980400X	1-1/2	2-3/8	4900	7350	4550	3-3/32	1-7/16	2	9/16
	6980430X	1-9/16	2-5/8	5600	7700	3850	3-15/32	1-5/8	2-1/4	9/16
	6980440X	1-5/8	2-5/8	5950	8225	3850	3-15/32	1-5/8	2-1/4	9/16
	6980460X	1-11/16	2-5/8	6475	8575	3850	3-15/32	1-5/8	2-1/4	9/16
	6980480X	1-3/4	2-5/8	7000	8925	3850	3-15/32	1-5/8	2-1/4	9/16
	6980510X	1-13/16	2-7/8	7700	9275	2940	4-3/64	1-15/16	2-1/2	5/8
6980520X	1-7/8	2-7/8	8225	9800	2940	4-3/64	1-15/16	2-1/2	5/8	
6980540X	1-15/16	2-7/8	8925	10150	2940	4-3/64	1-15/16	2-1/2	5/8	
6980560X	2	2-7/8	9800	10500	2940	4-3/64	1-15/16	2-1/2	5/8	
Large Series	Consult Factory	2-1/16	3-1/8	9975	10570	2450	4-15/64	2-1/16	2-3/4	5/8
	Consult Factory	2-1/8	3-1/8	10150	10640	2450	4-15/64	2-1/16	2-3/4	5/8
	Consult Factory	2-3/16	3-1/8	10325	10675	2450	4-15/64	2-1/16	2-3/4	5/8
	Consult Factory	2-1/4	3-1/8	10500	10693	2450	4-15/64	2-1/16	2-3/4	5/8
	Consult Factory	2-5/16	3-3/8	10675	10731	1960	4-7/32	2-3/16	3	11/16
	Consult Factory	2-3/8	3-3/8	10850	10780	1960	4-7/32	2-3/16	3	11/16
	Consult Factory	2-7/16	3-3/8	11025	10836	1960	4-7/32	2-3/16	3	11/16
	Consult Factory	2-1/2	3-3/8	11200	10885	1960	4-7/32	2-3/16	3	11/16
	Consult Factory	2-9/16	3-5/8	11375	10934	1680	4-9/16	2-5/16	3-1/4	11/16
	Consult Factory	2-5/8	3-5/8	11550	10976	1680	4-9/16	2-5/16	3-1/4	11/16
	Consult Factory	2-11/16	3-5/8	11725	11025	1680	4-9/16	2-5/16	3-1/4	11/16
	Consult Factory	2-3/4	3-5/8	11900	11060	1680	4-9/16	2-5/16	3-1/4	11/16
	Consult Factory	2-13/16	3-7/8	12075	11130	1610	4-1/2	2-7/16	3-1/2	3/4
	Consult Factory	2-7/8	3-7/8	12250	11165	1610	4-1/2	2-7/16	3-1/2	3/4
	Consult Factory	2-15/16	3-7/8	12425	11218	1610	4-1/2	2-7/16	3-1/2	3/4
	Consult Factory	3	3-7/8	12600	11305	1610	4-1/2	2-7/16	3-1/2	3/4

Specifications

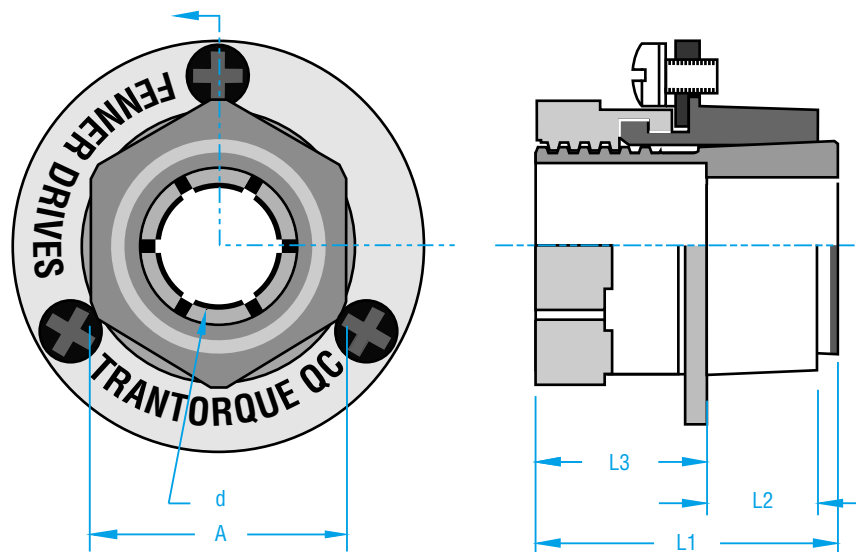

Part No.	Equivalent Bushing	Shaft Dia. d	L1	L2	L3	A	Installation Torque Ft-Lbs.	Max. Transmissible Torque, T In.-Lbs.	Min. RPM* for Max. HP Rating (timing belts)
63SK0137	SK	1-3/8	2.63	1-1/4	1.38	2-1/2	325	7524	10
63SK0143	SK	1-7/16	2.63	1-1/4	1.38	2-1/2	325	7956	10
63SK0150	SK	1-1/2	2.63	1-1/4	1.38	2-1/2	325	8388	10
63SK0156	SK	1-9/16	2.63	1-1/4	1.38	2-1/2	325	8820	10
63SK0162	SK	1-5/8	2.63	1-1/4	1.38	2-1/2	325	9264	10
63SK0168	SK	1-11/16	2.63	1-1/4	1.38	2-1/2	325	9696	10
63SK0175	SK	1-3/4	2.63	1-1/4	1.38	2-1/2	325	10128	10
63SK0181	SK	1-13/16	2.63	1-1/4	1.38	2-1/2	325	10572	10
63SK0187	SK	1-7/8	2.63	1-1/4	1.38	2-1/2	325	11004	10
63SK0193	SK	1-15/16	2.63	1-1/4	1.38	2-1/2	325	11436	10
63SK0200	SK	2	2.63	1-1/4	1.38	2-1/2	325	11868	10
63SF0100	SF	1	2.66	1-1/4	1.41	2-3/4	440	3372	Consult Factory
63SF0112	SF	1-1/8	2.66	1-1/4	1.41	2-3/4	440	4308	Consult Factory
63SF0125	SF	1-1/4	2.66	1-1/4	1.41	2-3/4	440	5232	Consult Factory
63SF0131	SF	1-5/16	2.66	1-1/4	1.41	2-3/4	440	5700	Consult Factory
63SF0137	SF	1-3/8	2.66	1-1/4	1.41	2-3/4	440	6168	200
63SF0143	SF	1-7/16	2.66	1-1/4	1.41	2-3/4	440	6636	200
63SF0150	SF	1-1/2	2.66	1-1/4	1.41	2-3/4	440	7092	60
63SF0156	SF	1-9/16	2.66	1-1/4	1.41	2-3/4	440	7560	40
63SF0162	SF	1-5/8	2.66	1-1/4	1.41	2-3/4	440	8028	20
63SF0168	SF	1-11/16	2.66	1-1/4	1.41	2-3/4	440	8496	10
63SF0175	SF	1-3/4	2.66	1-1/4	1.41	2-3/4	440	8952	10
63SF0181	SF	1-13/16	2.66	1-1/4	1.41	2-3/4	440	9420	10
63SF0187	SF	1-7/8	2.66	1-1/4	1.41	2-3/4	440	9888	10
63SF0193	SF	1-15/16	2.66	1-1/4	1.41	2-3/4	440	10344	10
63SF0200	SF	2	2.66	1-1/4	1.41	2-3/4	440	10812	10
63SF0212	SF	2-1/8	2.66	1-1/4	1.41	2-3/4	440	11748	10
63SF0218	SF	2-3/16	2.66	1-1/4	1.41	2-3/4	440	12204	10
63SF0225	SF	2-1/4	2.66	1-1/4	1.41	2-3/4	440	12672	10

*"Minimum RPM" is based on the highest catalog ratings for Kevlar®/Polyurethane synchronous belts. Consult Factory if drive RPM is less than specified "Minimum RPM."

Specifications

Part No.	Equivalent Bushing	Shaft Dia. d	L1	L2	L3	A	Installation Torque Ft.-Lbs.	Max. Transmissible Torque, T In.-Lbs.	Min. RPM* at Max. HP Rating (timing belts)
63JA0050	JA	1/2	1.47	9/16	0.91	1 1/4	50	768	20
63JA0056	JA	9/16	1.47	9/16	0.91	1 1/4	50	900	10
63JA0062	JA	5/8	1.47	9/16	0.91	1 1/4	50	1020	10
63JA0068	JA	11/16	1.47	9/16	0.91	1 1/4	50	1152	10
63JA0075	JA	3/4	1.47	9/16	0.91	1 1/4	50	1284	10
63SH0075	SH	3/4	1.89	3/4	1.14	1 3/4	125	2352	40
63SH0081	SH	13/16	1.89	3/4	1.14	1-3/4	125	2604	20
63SH0087	SH	7/8	1.89	3/4	1.14	1-3/4	125	2856	10
63SH0093	SH	15/16	1.89	3/4	1.14	1-3/4	125	3108	10
63SH0100	SH	1	1.89	3/4	1.14	1-3/4	125	3372	10
63SH0106	SH	1-1/16	1.89	3/4	1.14	1-3/4	125	3624	10
63SH0112	SH	1-1/8	1.89	3/4	1.14	1-3/4	125	3876	10
63SH0118	SH	1-3/16	1.89	3/4	1.14	1-3/4	125	4128	10
63SH0125	SH	1-1/4	1.89	3/4	1.14	1-3/4	125	4380	10
63DS0075	SDS	3/4	2.01	3/4	1.26	2	145	2508	10
63DS0081	SDS	13/16	2.01	3/4	1.26	2	145	2784	10
63DS0087	SDS	7/8	2.01	3/4	1.26	2	145	3048	10
63DS0093	SDS	15/16	2.01	3/4	1.26	2	145	3324	10
63DS0100	SDS	1	2.01	3/4	1.26	2	145	3588	10
63DS0106	SDS	1-1/16	2.01	3/4	1.26	2	145	3864	10
63DS0112	SDS	1-1/8	2.01	3/4	1.26	2	145	4140	10
63DS0118	SDS	1-3/16	2.01	3/4	1.26	2	145	4404	10
63DS0125	SDS	1-1/4	2.01	3/4	1.26	2	145	4680	10
63DS0131	SDS	1-5/16	2.01	3/4	1.26	2	145	4944	10
63DS0137	SDS	1-3/8	2.01	3/4	1.26	2	145	5220	10
63DS0143	SDS	1-7/16	2.01	3/4	1.26	2	145	5484	10
63DS0150	SDS	1-1/2	2.01	3/4	1.26	2	145	5760	10
63SD0075	SD	3/4	2.51	1-1/4	1.26	2	190	2964	40
63SD0081	SD	13/16	2.51	1-1/4	1.26	2	190	3372	10
63SD0087	SD	7/8	2.51	1-1/4	1.26	2	190	3780	10
63SD0093	SD	15/16	2.51	1-1/4	1.26	2	190	4188	10
63SD0100	SD	1	2.51	1-1/4	1.26	2	190	4596	10
63SD0106	SD	1-1/16	2.51	1-1/4	1.26	2	190	5004	10
63SD0112	SD	1-1/8	2.51	1-1/4	1.26	2	190	5412	10
63SD0118	SD	1-3/16	2.51	1-1/4	1.26	2	190	5820	10
63SD0125	SD	1-1/4	2.51	1-1/4	1.26	2	190	6228	10
63SD0131	SD	1-5/16	2.51	1-1/4	1.26	2	190	6636	10
63SD0137	SD	1-3/8	2.51	1-1/4	1.26	2	190	7044	10
63SD0143	SD	1-7/16	2.51	1-1/4	1.26	2	190	7452	10
63SD0150	SD	1-1/2	2.51	1-1/4	1.26	2	190	7860	10
63SK0075	SK	3/4	2.63	1-1/4	1.38	2-1/2	325	3168	Consult Factory
63SK0087	SK	7/8	2.63	1-1/4	1.38	2-1/2	325	4032	Consult Factory
63SK0100	SK	1	2.63	1-1/4	1.38	2-1/2	325	4908	200
63SK0106	SK	1-1/16	2.63	1-1/4	1.38	2-1/2	325	5340	100
63SK0112	SK	1-1/8	2.63	1-1/4	1.38	2-1/2	325	5772	40
63SK0118	SK	1-3/16	2.63	1-1/4	1.38	2-1/2	325	6216	20
63SK0125	SK	1-1/4	2.63	1-1/4	1.38	2-1/2	325	6648	10
63SK0131	SK	1-5/16	2.63	1-1/4	1.38	2-1/2	325	7080	10